

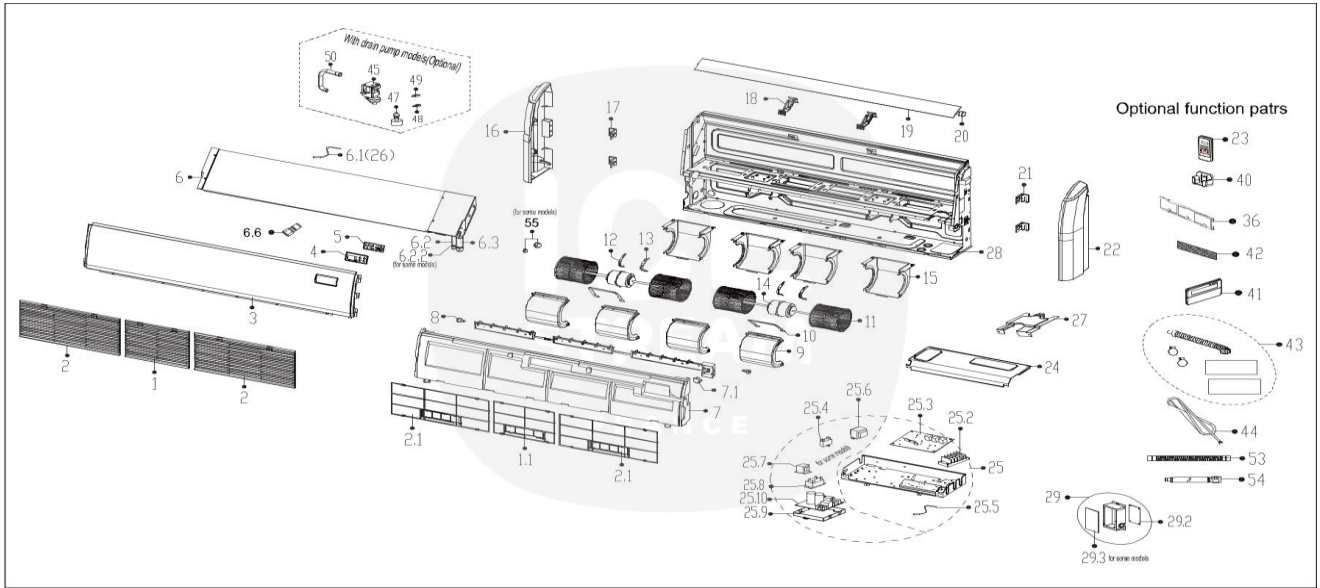

IFS602DRIV2 - Unité intérieure - Vue éclatée/ Indoor Unit - Exploded View



IFS602DRIV2	Pièces détachées/ Spare parts		
	Code	Pièces / Part Name	Quantité
1	12122700000103	Return Air Grille Subassembly	1
1.1	12100204000719	Air filter	1
2	12122700000096	Return Air Grille Subassembly	2
2.1	12100204000718	Air filter	1
3	12222700A00035	Top cover	1
4	12122700A00010	Display installation box	1
5	17122700A00001	Display board subassembly	1
6	15822700001543	Evaporator Assembly	1
6.1	11201007000047	Pipe Temperature Sensor	1
6.2	15122700001697	Evaporator inlet pipe subassembly	1
6.3	15122700000186	Evaporator outlet pipe subassembly	1
6.6	15500209000002	Pin Valve	1
7	12822700000009	Water collector subassembly	1
7.1	11002010000546	Stepper Motor	1
8	12122000000344	Electricity Preventing Axis	2
9	12122700000756	Volute Shell (Above)	4
10	12223000000537	Fan motor fixing board	2
11	12100103000165	Plastic Fan	4
12	12222500000255	Cover	2
13	12222500000253	Fan Motor Axes Clamp (Left)	2
14	11002015002521	Brushless DC Motor	2
15	12122700000755	Volute Shell (Below)	4
16	12122700000087	Cover Plate	1
17	12222700000018	Right hook	2
18	12122700000150	Supporter of louver	2
19	12122700000718	Louver Subassembly	1
20	11002010000057	Stepper Motor	1
21	12222700000016	Left Hook	2
22	12122700000093	Cover Plate	1
23	17317000A61887	Remote controller	1
24	12222700000727	Cover of electronic control box subassembly	1
25	17222700A03516	Electronic control box subassembly	1
25.2	17400401000097	Wire Joint	1
25.3	17122700A02647	Main control board subassembly	1
25.5	11201007002321	Room Temperature Sensor	1
25.7	17400306000020	Reactor	1
25.9	12122000014182	Electronic Installing Box	1
25.10	17122000051651	Inverter module subassembly	1
27	12222700001206	Piping platen assembly	1
28	12222700000228	Chassis assembly	1